

01

Job
forming.

PN:P020-032186

ORIFICE PAN 10"

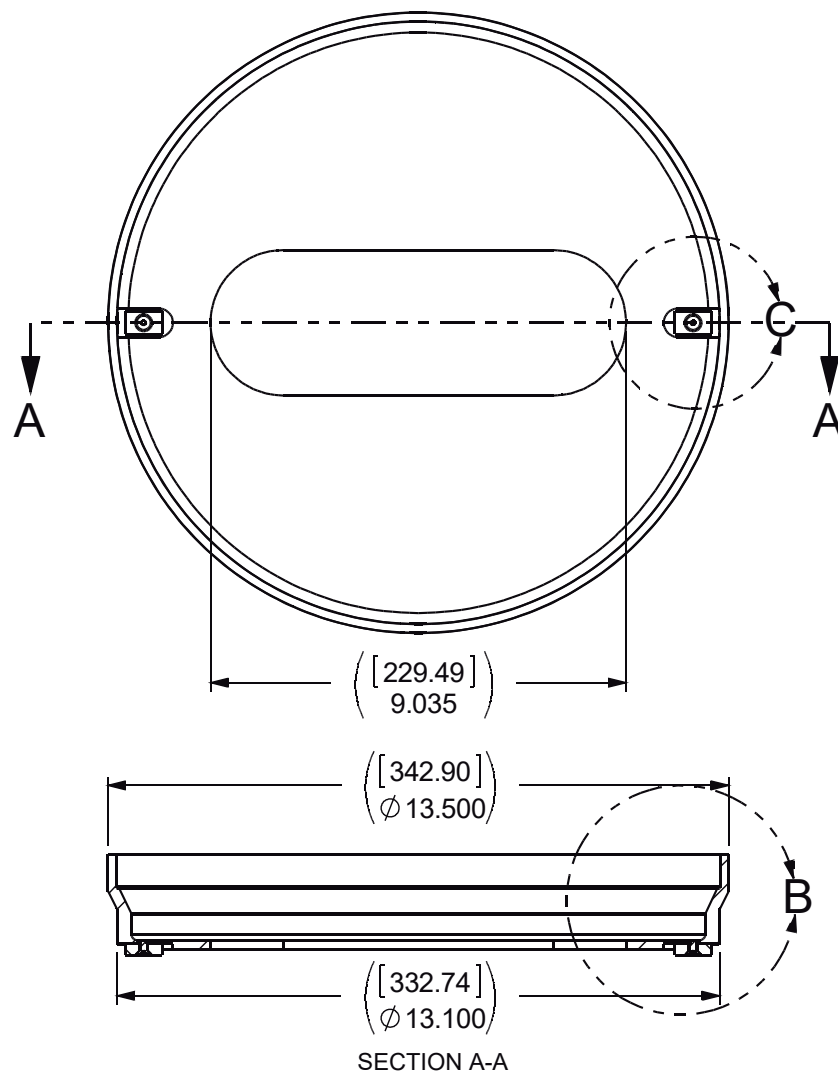

Putsch blades

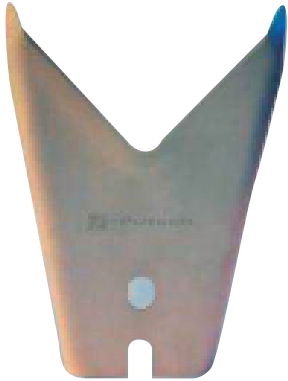

**Shear blade
SM 1775 F/S**

Single and double
gob for bottles,
container glass and
household glass



**Shear blade
SM 5230 F/S**

Double gob and
triple gob for
bottles, container
glass and
household glass



**Shear blade
SM 2316 F/S**

Double, triple and
quadruple gob for
small bottles and
household glass



**Shear blade
SM 3167**

Single and double
gob for heavy glass
articles up to 10 lb.
(5 kg) weight



**Shear blade
SM 3533**

For technical,
optical and crystal
glass



**Shear blade
SM 3299**

For very heavy
glass articles up to
16 lb. (8 kg) weight

Putsch blades

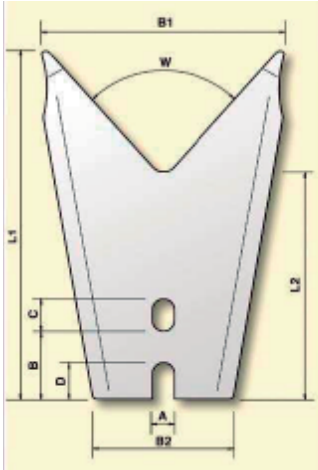

	2-SM 1775	2-SM 5230	2-SM 2316	2-SM 4031
Gob Ø max.	2.56"	2.16"	1.57"	0.98"
Gob	Single, double	Single, double, triple	Single, double, triple, quadruple	Triple, quadruple
W	84°	85°	85°	85°
B1	4.29"	3.54"	2.72"	1.69"
B2	2.44"	2.05"	2.05"	1.69"
L1	6.14"	5.71"	5.24"	4.72"
L2	3.96"	4.00"	3.98"	3.98"
A	0.39"	0.39"	0.39"	0.39"
B	1.20"	1.20"	1.20"	1.20"
C	0.55"	0.55"	0.55"	0.55"
D	0.63"	0.63"	0.63"	0.63" 3.98"
Cutting Edge				
Straight	30°	30°	30°	
Straight	45°	45°	45°	
Straight	30°/60°	30°/60°	30°/60°	
Rounded	Special	Special	Special	

Loading Funnel

GRAPHITE FUNNEL, 14 IN

PN 9099-GDF-0080

ITEM NO.	PART NUMBER	"X"
1	9099-GDF-0080-A	1 1/4 in
2	9099-GDF-0080-B	1 3/8 in
3	9099-GDF-0080-C	1 1/2 in
4	9099-GDF-0080-D	1 5/8 in
5	9099-GDF-0080-E	1 3/4 in
6	9099-GDF-0080-F	1 7/8 in
7	9099-GDF-0080-G	2 in

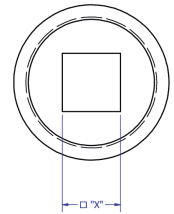
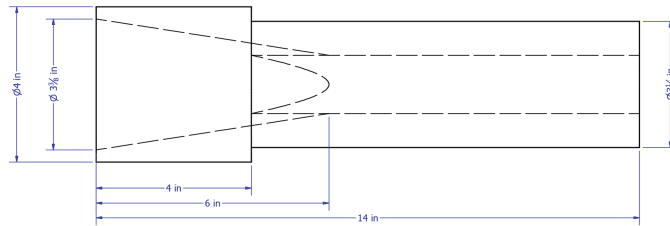
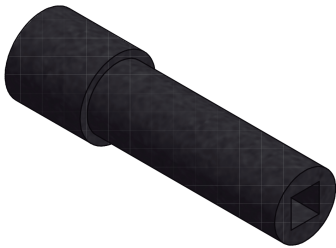

GRAPHITE FUNNEL, L 18 IN

PN 9099-GDF-0081

ITEM NO.	PART NUMBER	"X"
1	9099-GDF-0081-A	1 1/4 in
2	9099-GDF-0081-B	1 3/8 in
3	9099-GDF-0081-C	1 1/2 in
4	9099-GDF-0081-D	1 5/8 in

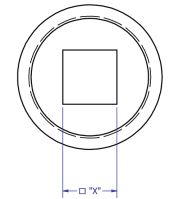
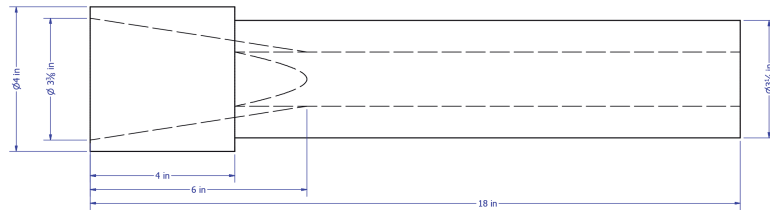

GRAPHITE FUNNEL, L 24 IN

PN 9099-GDF-0082

ITEM NO.	PART NUMBER	"X"
1	9099-GDF-0080-A	1 1/4 in
2	9099-GDF-0080-B	1 3/8 in
3	9099-GDF-0080-C	1 1/2 in

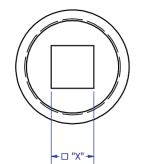
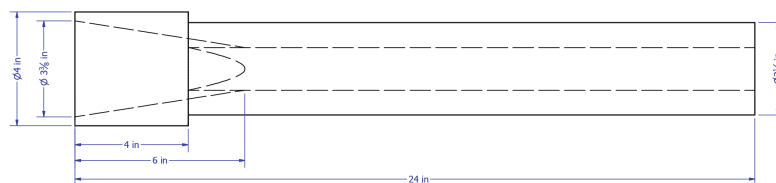

Loading Funnel Order Form

